

RoHS & REACH Compliant

CAK3 & CAK6 Transient Voltage Suppressors Ideal for 5G transmitters

3kA, 12-380V | 6kA, 42-240V

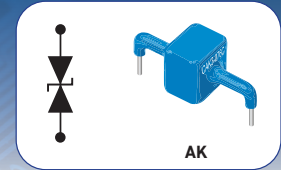

Central Semiconductor's **CAK3** & **CAK6** series are bi-directional glass passivated junction transient voltage suppressors (TVS) designed to protect voltage sensitive components from high voltage transients. Manufactured with glass passivated chips to deliver exceptional reliability, these highly energy efficient devices utilize the AK case, with voltage options ranging from 12V to 380V (3kA) and 42V to 240V (6kA). Ideal for high voltage 5G transmitter applications, these transient voltage suppressors also feature a clamping voltage as low as 28V.

Features

- Very low clamping voltage (as low as 28V)
- Bi-directional TVS
- ESD protection of data lines in accordance with IEC 61000-4-2

Applications

- 5G telecom power supplies
- High power surge protection

Benefits

- Energy efficiency
- Glass passivated chip for optimum reliability
- Wide voltage range

Maximum Ratings (T _A = 25°C)				Electrical Characteristics: (T _A = 25°C unless otherwise noted)						
Central Item No.	I _{PP} kA	V _{ESD} (Air) (kV)	T _J , T _{stg} (°C)	Maximum Reverse Stand-off Voltage		Minimum Breakdown Voltage V _{BR} @ I _T V	Test Current I _T mA	Maximum Reverse Leakage Current I _R @ V _{DC} µA	Maximum Clamping Voltage (8x20µs)	
				V _{AC} V	V _{DC} V				V _R @ 3kA V	V _R @ 6kA V
CAK3-012C	3	15	-55 to +150	8.5	12.8	14	10	20	28	-
CAK3-015C	3	15		11	15	17	10	20	30	-
CAK3-020C	3	15		14	20	22	10	20	40	-
CAK3-025C	3	15		17	25	28	10	20	50	-
CAK3-030C	3	15		21	30	33	10	20	90	-
CAK3-042C	3	15		30	42	47	10	20	100	-
CAK3-058C	3	15		40	58	64	10	20	110	-
CAK3-076C	3	15		54	76	85	10	20	140	-
CAK3-380C	3	15		275	380	401	10	20	520	-
CAK6-042C	6	15		30	42	47	10	20	-	100
CAK6-066C	6	15		45	66	70	10	20	-	125
CAK6-076C	6	15		54	76	83	10	20	-	135
CAK6-170C	6	15		130	170	180	10	20	-	260
CAK6-190C	6	15		145	190	200	10	20	-	290
CAK6-240C	6	15		180	240	250	10	20	-	340

Note: 10kA and 15kA options (**CAK10** and **CAK15** series) are under development.

SPICE Models, Package Details and other technical resources:

Engineering resources are available at www.centralsemi.com.

RoHS and REACH compliance declarations

Visit the Quality section of Central's website to access.

Typical Electrical Characteristics:

Peak Pulse Power: CAK3-076C

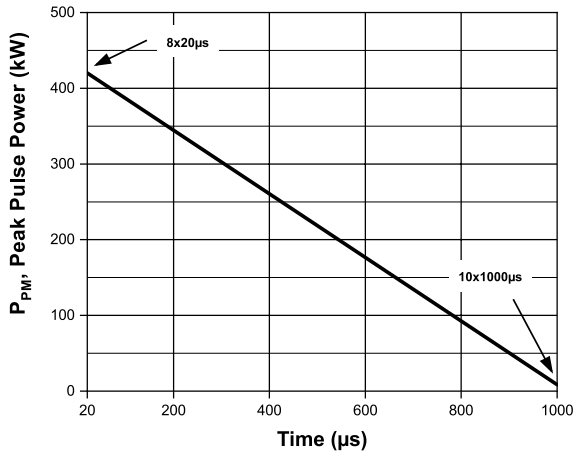

Peak Pulse Power: CAK6-190C

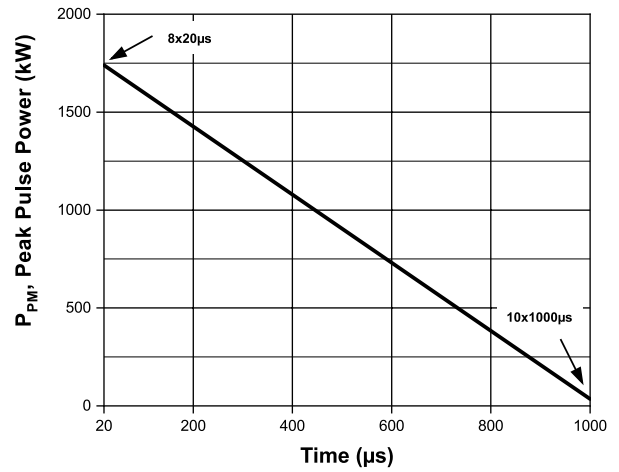

8x20µs Surge Response: CAK3-076C

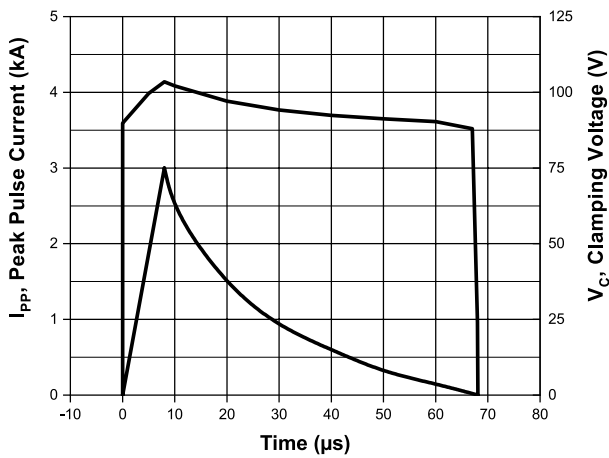

8x20µs Surge Response: CAK6-190C

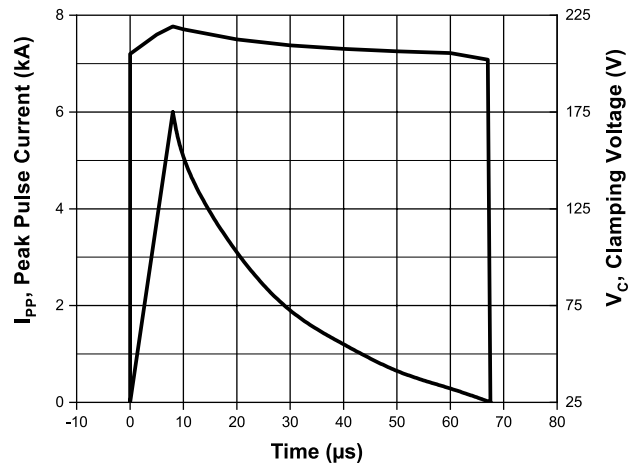

Example Application:

High Voltage Transient Voltage Suppression:

Central Semiconductor's transient voltage suppression (TVS) diodes can be used in any application where protection against overvoltage with a very large current is required, whether it be in data lines or power transmission. The device can simply be connected in parallel to the circuit in question with one side being grounded. This includes protection against lightning strikes, which may have overcurrent in the thousands of amps.

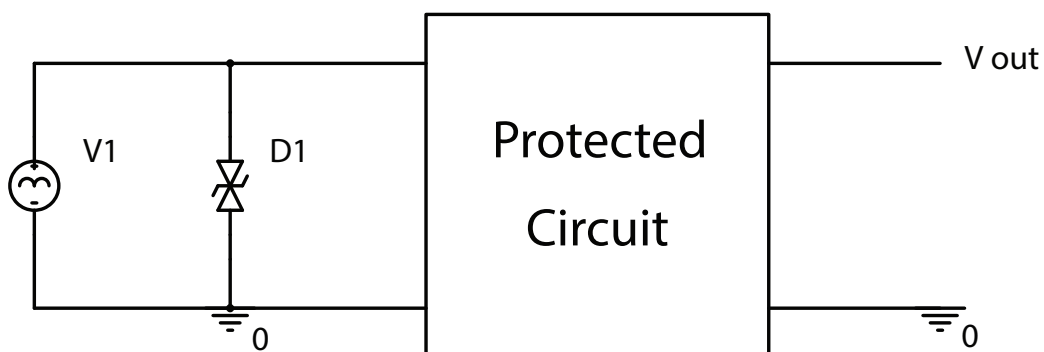

**Mechanical Drawing:
AK**

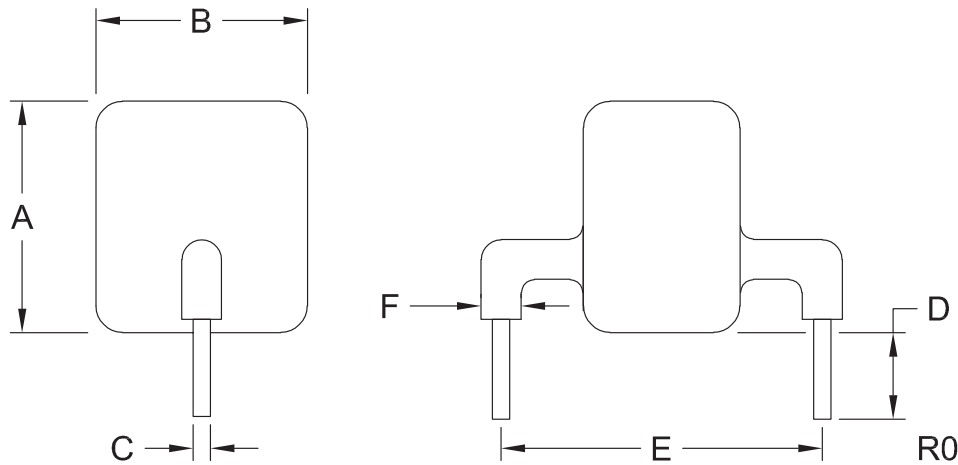

SYMBOL	INCHES		MILLIMETERS	
	MIN	MAX	MIN	MAX
A	-	0.685	-	17.40
B	-	0.626	-	15.90
C (DIA)	0.047	0.055	1.20	1.40
D	0.256	0.295	6.50	7.50
E	0.923	0.978	23.45	24.85
F (DIA)	-	0.157	-	4.00

AK (REV: R0)

Packing Information and Packaging Base

Note: Due to the characteristics of the AK package, CAK3-012C and CAK6-042C series transient voltage suppressors are only available in bulk packaging.

Packing Method	Quantity
Bulk (Box)	150 pcs.

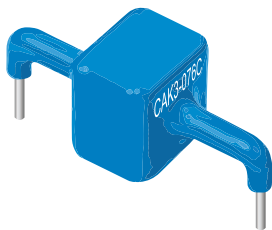

Custom solutions also available:

- custom device development
- special wafer diffusions
- custom interconnect options
- packaging options
- specialized parametric testing
- up-screening to MIL standard equivalents or to customer-specific criteria

For more information on Central's products and solutions:

Call us at: **1.631.435.1110**

Or view online: **www.centrasemi.com/featured-products**

Custom
Solutions
Available

**Just
Ask**