



## Uninterruptible Power Supply (UPS)



The latest Uninterruptible Power Supplies (UPSs) must maximize the efficient storage and conversion of energy for use during power outage occurrences. To accomplish this task, UPS designers must select semiconductor components that provide tangible gains in energy efficiency without undesirable performance trade-offs. Central Semiconductor manufactures discrete semiconductor solutions designed to minimize total conduction losses ideal for UPS applications.

For more information visit: [www.centrasemi.com/applications](http://www.centrasemi.com/applications)

### Uninterruptible Power Supply (UPS) Topology

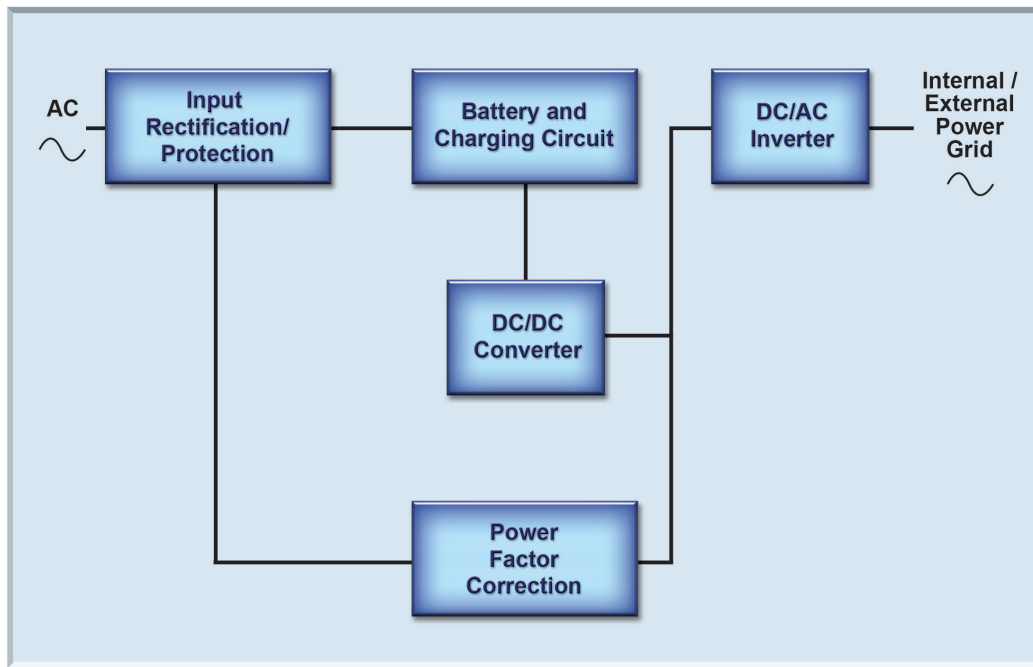

#### Input Rectification / Protection

##### • Transient Voltage Suppressors (TVSs)

-  3SMC170CA: 3000W Peak, 170V bi-directional, 5% TVS (SMC)
- 1.5SMC170CA: 1500W Peak, 170V bi-directional, TVS (SMC)
- 1.5SMC200CA: 1500W Peak, 200V bi-directional, 5% TVS (SMC)
- 1.5SMC220CA: 1500W Peak, 220V bi-directional, 5% TVS (SMC)

##### • Bridge Rectifiers (Full Wave)

-  CBR2-D060S: 2.0A, 600V full-wave bridge (SMDIP)
- CBRDFA4-100: 4.0A, 1000V full-wave bridge (BR DFN-A)
- CBR6M-L060: 6.0A, 600V full-wave bridge (Case DM)
- CBR8M-L060: 8.0A, 600V full-wave bridge (Case DM)
- CBR25-060P: 25A, 600V full-wave bridge (Case FP)

#### Power Factor Correction

##### • Rectifiers

-  CMR3S-06: 3.0A, 600V, 35ns Super Fast rectifier (SMC)
- CHD8-06: 8.0A, 600V, 25ns HyperFast rectifier (DPAK)
- CUD10-06: 10A, 600V, 35ns, Ultra Fast rectifier (DPAK)

#### DC/DC Converter

##### • Rectifiers





-  CMR1H-04MFL: 1.0A, 400V, 25ns HyperFast rectifier (SMAFL)
- CMR2S-06: 2.0A, 600V, 30ns Super Fast rectifier (SMB)
- CMR3S-06: 3.0A, 600V, 35ns Super Fast rectifier (SMC)
- CMR5U-06: 5.0A, 600V, 100ns Ultra Fast rectifier (SMC)
- CHD8-06: 8.0A, 600V, 25ns HyperFast rectifier (DPAK)



## Battery and Charging Circuit



### • Schottky Rectifiers



	CMSH3-40FL:	3.0A, 40V, Schottky rectifier, Low Profile (SMBFL)
	CMSH5-40FL:	5.0A, 40V, Schottky rectifier, Low Profile (SMBFL)
	CSHDD8-60:	8.0A, 60V, Schottky rectifier (DPAK)
	CTLSH10-45M364:	10A, 45V, Schottky rectifier (TLM364)
	CTLSH15-60M364:	15A, 60V, Low $V_F$ , Schottky rectifier, Low Profile (TLM364)
	CMDFSHC3-100:	3.0A, 100V, Schottky rectifier, Low Profile (SMC DFN)
	CMDFSHC5-100:	5.0A, 100V, Schottky rectifier, Low Profile (SMC DFN)

### • MOSFETs



	CMPDM303NH:	3.6A, 30V, N-Channel MOSFET (SOT-23F)
	CMPDM302PH:	2.4A, 30V, P-Channel MOSFET (SOT-23F)
	CXDM4060N:	6.0A, 40V, N-Channel MOSFET (SOT-89)
	CXDM4060P:	6.0A, 40V, P-Channel MOSFET (SOT-89)
	CWDM3011N:	11A, 30V, N-Channel MOSFET (SOIC-8)
	CWDM3011P:	11A, 30V, P-Channel MOSFET (SOIC-8)

### • Zener Diodes





	CMZ5338B:	5.1V, 5W, Zener Diode (SMC)
	CMZ5349B:	12V, 5W, Zener Diode (SMC)
	CMZ5352B:	15V, 5W, Zener Diode (SMC)

## DC/AC Inverter

### • Rectifiers



	CMR3S-06:	3.0A, 600V, 35ns Super Fast rectifier (SMC)
	CMR5U-06:	5.0A, 600V, 100ns Ultra Fast rectifier (SMC)
	CHD8-06:	8.0A, 600V, 25ns HyperFast rectifier (DPAK)
	CUD10-06:	10A, 600V, 35ns, Ultra Fast rectifier (DPAK)

## Samples



To order samples of these devices,  
search by Central part number:  
[www.centrasemi.com/samples](http://www.centrasemi.com/samples)