



Pulse Oximeter



A current trend in medical equipment development is to condense larger diagnostic devices into smaller and lighter interactive mobile units. The pulse oximeter indirectly monitors the oxygen saturation of a patient's blood and is the latest apparatus to be streamlined and available for home use. The pulse oximeter utilizes light to measure hemoglobin conditions and when attached to a monitor, stores and exchanges critical patient data. Central's small outline and high efficiency product offering is ideally suited for the demands of these new technologies.

For more information visit: www.centrasemi.com/product/pulseox

Pulse Oximeter Topology

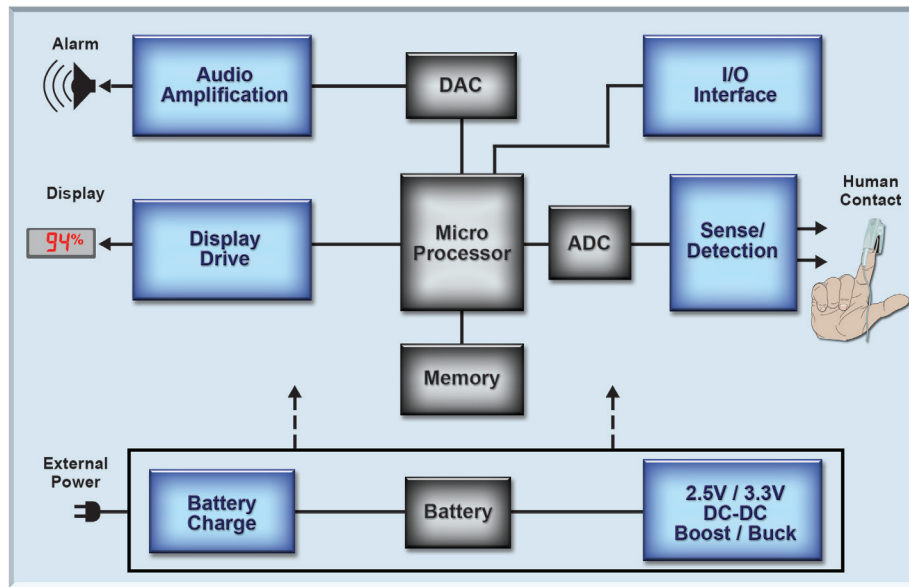

Audio Amplification

• Small Signal Transistors

- CMUT3904: 200mA, 40V NPN (SOT-523)
- CMUT3906: 200mA, 40V PNP (SOT-523)
- CMUT5088E: 100mA, 50V Low Noise PNP (SOT-523)
- CMUT5087E: 100mA, 50V Low Noise NPN (SOT-523)

• Schottky Diodes

- CFSH01-30: 100mA, 30V (SOD-882L)
- CMLSH05-4: 0.5A, 40V Low V_F (SOT-563)
- CMLSH1-40: 1.0A, 40V (SOT-563)
- CMASH-4: 200mA, 40V (SOD-923)
- CMLSH-4: 200mA, 40V (SOT-563)

• High Speed Switching Diodes

- CMLD4448: 250mA, 120V Dual Isolated (SOT-563)
- CMAD4448: 250mA, 120V (SOD-923)

For more information visit: www.centrasemi.com/apps/aa5

I/O Interface

• Uni-polar Transient Voltage Suppressors

- CMF5.0A thru CMF12A: 200W, 5.0V thru 12V (SOD-123F)

• ESD Transient Voltage Suppressors

- CSL05: 400W, 5.0V Low Capacitance (SOT-23)
- CSL05D: 400W, 5.0V Dual, Low Capacitance (SOT-23)

• TVS/Zener Array

- CMNTVS12V: 18W, 12V (SOT-953)

• Multi Discrete Modules (MDMs)

- Combination:
 - CMLM0574: 450mA, 30V N-Channel MOSFET and 0.5A, 40V Schottky Diode (SOT-563)
- Combination:
 - CMLM0305T: 280mA, 50V P-Channel MOSFET and 0.5A, 40V Schottky Diode (SOT-563)

For more information visit: www.centrasemi.com/apps/loi5

Sense / Detection, Display Drive, and 2.5V / 3.3V Boost / Buck DC-DC and Battery Charger continued on reverse side







Medical

Display Drive



• Schottky Diodes



-  -CTLSH01-30: 100mA, 30V Low Leakage (TLM2D3D6)
-  -CMUD6263CE: 70mA, 70V Common Cathode (SOT-523)
-  -CMOSH-3: 100mA, 30V (SOD-523)
-  -CMASH-4: 200mA, 40V (SOD-923)
- CMLSH-4: 200mA, 40V Dual (SOT-563)



• High Speed Switching Diodes



-  -CMDD2004: 200mA, 240V (SOD-323)
-  -CMLD4448: 250mA, 120V Dual, Isolated (SOT-563)

• MOSFETs





-  -CMLDM7002A: 280mA, 60V N-Channel Dual (SOT-563)
-  -CMLDM8002A: 280mA, 50V P-Channel Dual (SOT-563)

For more information visit: www.centrasemi.com/apps/dd5

Sense / Detection



• High Speed Switching Diodes



-  -CMLD4448: 250mA, 120V Dual, Isolated (SOT-563)
-  -CMAD4448: 250mA, 120V (SOD-923)

• Schottky Diodes









-  -CTLSH01-30: 100mA, 30V Low Leakage (TLM2D3D6)
-  -CTLSH01-30L: 100mA, 30V Low V_F (TLM2D3D6)
-  -CMRSH-4DO: 200mA, 40V Dual Opposing (SOT-963)

For more information visit: www.centrasemi.com/apps/sd5

2.5V / 3.3V Boost / Buck DC-DC and Battery Charger



• MOSFETs



-  -CMLDM7005: 650mA, 20V N-Channel Dual (SOT-563)
-  -CMUDM7005: 650mA, 20V N-Channel (SOT-523)
-  -CMUDM8005: 650mA, 20V P-Channel (SOT-523)
-  -CEDM8004: 450mA, 30V P-Channel (SOT-883L)
-  -CMLDM7002A: 280mA, 60V N-Channel Dual (SOT-563)
-  -CMLDM8002A: 280mA, 50V P-Channel Dual (SOT-563)





• Schottky Diodes



-  -CMLSH05-4: 0.5A, 40V Low V_F (SOT-563)
-  -CMLSH1-40: 1.0A, 40V (SOT-563)





• Small Signal Transistors



-  -CTLT7410-M621: 1.0A, 40V Low $V_{CE(SAT)}$ PNP (TLM621)
-  -CMST7410: 1.0A, 25V Low $V_{CE(SAT)}$ PNP (SOT-323)
-  -CMUT3410: 1.0A, 25V Low $V_{CE(SAT)}$ NPN (SOT-523)
-  -CMUT7410: 1.0A, 25V Low $V_{CE(SAT)}$ PNP (SOT-523)

• Multi Discrete Modules (MDMs)



-  -CMLM0574: **Combination:** 450mA, 30V N-Channel MOSFET and 0.5A, 40V Schottky Diode (SOT-563)
-  -CMLM0584: **Combination:** 450mA, 30V P-Channel MOSFET and 0.5A, 40V Schottky Diode (SOT-563)
-  -CMLM0705: **Combination:** 600mA, 60V PNP Transistor and 0.5A, 40V Schottky Diode (SOT-563)
-  -CMLM2205: **Combination:** 600mA, 45V NPN Transistor and 0.5A, 40V Schottky Diode (SOT-563)

For more information visit: www.centrasemi.com/apps/bbdd5

Samples

To order samples of these devices visit:
<http://web.centrasemi.com/search/sample.php>

Literature

Order your selection guide today.
Visit: web.centrasemi.com/search/sample.php



Innovative Discrete Semiconductors

For further information contact:
Sales at Central Semiconductor Corp.
(631) 435-1110 or visit:
www.centrasemi.com