

## PoE Audio Speakers



PoE speakers provide system flexibility and therefore can be placed anywhere in a facility where Ethernet connections are available, regardless of available power sources. In order to achieve desired levels of efficiency and size reduction, PoE speakers require energy efficient semiconductors packaged in very small, low profile outlines. Central Semiconductor manufactures a broad portfolio of discrete semiconductors that provide engineers with options for both reduced power consumption and decreased package size.

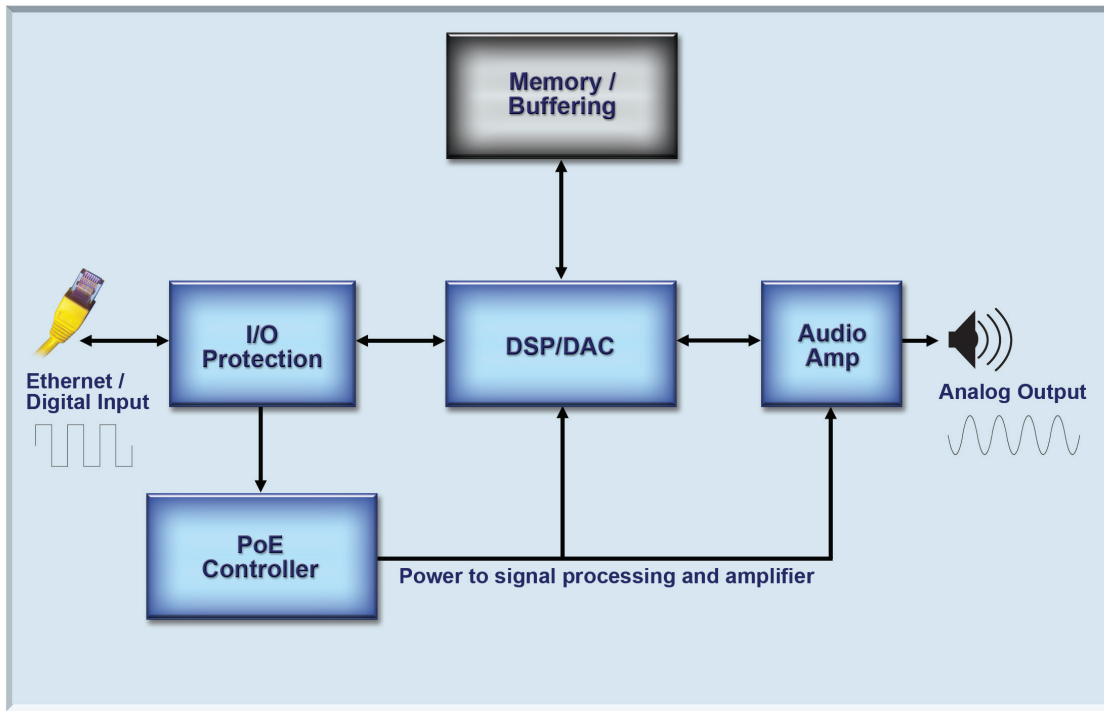

For more information visit: [www.centrasemi.com/applications](http://www.centrasemi.com/applications)

### PoE Audio Speakers Topology



#### I/O Protection

##### • Transient Voltage Suppressors (TVS)



-  - C4SMAFL58A: 58V, 400W TVS (SMAFL)
-  - 1SMB58CA: 58V, 600W bi-directional TVS (SMB)

##### • ESD Transient Voltage Suppressors



-  - CFTVS5V0BULC: 5V, ultra-low capacitance, bi-directional, low profile (SOD-882L)

#### DPS/DAC

##### • Zener Diodes

-  CMOZ5L1: 5.1V, 250mW, low idle current (SOD-523)
-  CMOZ12L: 12V, 250mW, low idle current (SOD-523)
-  - CMDZ5L1: 5.1V, 250mW, low idle current (SOD-323)

##### • ESD Transient Voltage Suppressors

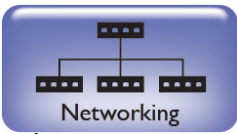

-  - CFTVS5V0BULC: 5V, ultra-low capacitance, bi-directional, low profile (SOD-882L)
-  - CMO5V0LC: 5V, low capacitance, low profile (SOD-523)
-  - CTLTVS5V0B: 5V, bi-directional, low profile (TLM2D3D6)



## Audio Amp



### • Small Signal Transistors



-  - CMLT3820G: 1A, 80V NPN Low  $V_{CE(SAT)}$  (SOD-882L)
-  - CMLT3474: 1A, 40V Dual NPN/PNP Low  $V_{CE(SAT)}$  (SOD-523)

### • MOSFETs



-  - CMLDM7002AG: 280mA, 60V, Dual, N-Channel (SOT-563)
-  - CMLDM8002AG: 280mA, 50V, Dual, P-Channel (SOT-563)

### • Zener Diodes







-  - CMOZ5L1: 5.1V, 250mW, low idle current Zener diode (SOD-523)

## PoE Controller

### • Schottky Bridge Rectifiers Full Wave



-  - CBRHDSH1-100: 1A, 100V Schottky Bridge (HD DIP)
-  - CBRHDSH2-100: 2A, 200V Schottky Bridge (HD DIP)
-  - CBRLDSH2-100: 2A, 100V Schottky Bridge (LPDIP)

-  - CBRDFSH1-40: 1.0A, 40V (BR DFN)
-  - CBRDFSH1-60: 1.0A, 60V (BR DFN)
-  - CBRDFSH1-100: 1.0A, 100V (BR DFN)
-  - CBRDFSH2-40: 2.0A, 40V (BR DFN)
-  - CBRDFSH2-60: 2.0A, 60V (BR DFN)
-  - CBRDFSH2-100: 2.0A, 100V (BR DFN)
-  - CBRDFSH3-40: 3.0A, 40V (BR DFN)
-  - CBRDFSH3-60: 3.0A, 60V (BR DFN)



### • Schottky Diodes



-  - CMOZ5L1: 5.1V, 250mW, low idle current Zener diode (SOD-882L)

### • MOSFETs



-  - CEDM7002AE: 300mA, 20V, low profile N-Channel MOSFET (SOT-883L)
-  - CEDM8004: 450mA, 30V, low profile P-Channel MOSFET (SOT-883L)

For more information on Central's products and potential solutions:

Call us at: **1.631.435.1110**

Or view online: [www.centrasemi.com](http://www.centrasemi.com)

