



Lighting

Application Brief



LED Driver



The Solid State Lighting (SSL) market demands increased brightness, enhanced efficiency and smaller size. To address these challenges, Central has developed devices with increased power density which allow for higher current ratings in smaller packages and enhanced overall efficiency. The net result is smaller, brighter and more efficient lighting.

For more information visit: www.centrasemi.com/applications



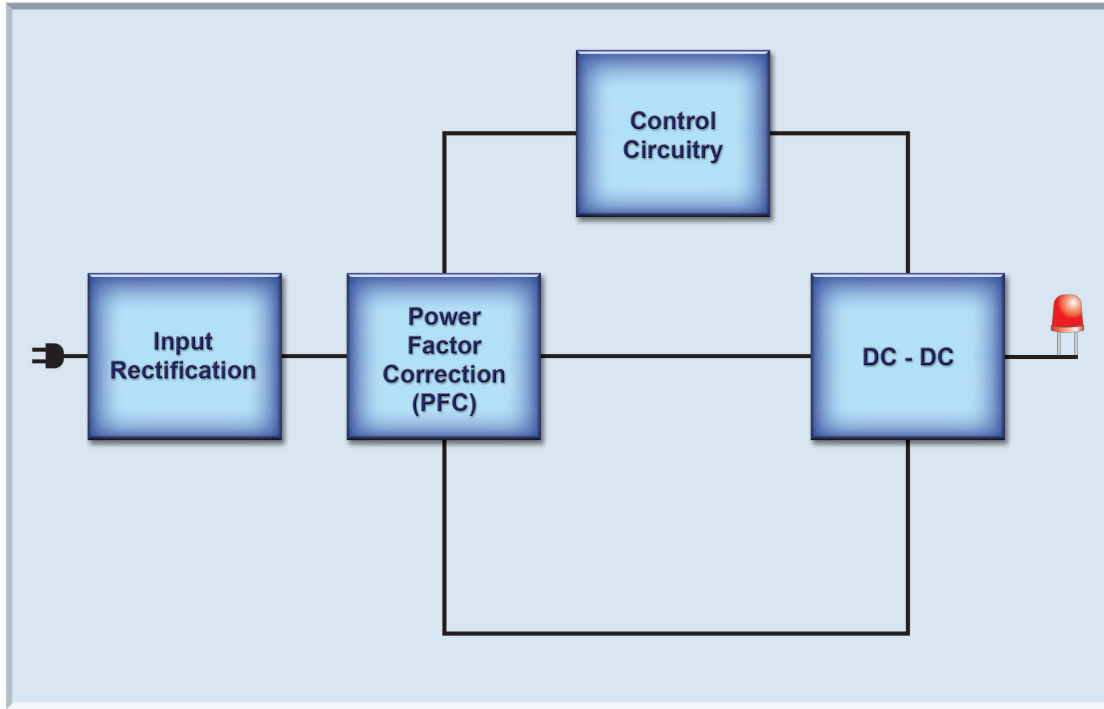



Typical Low Power LED Drive Circuitry



Input Rectification



• Bridge Rectifiers (Full Wave)



-  -CBRHD-04: 0.5A, 400V (HD DIP)
-  -CBR1-D040S: 1.0A, 400V (SMDIP)
-  -CBRSDSH1-40L: 1.0A, 40V Low V_F Schottky (SMDIP)
-  -CBRHDSH1-100: 1.0A, 100V Schottky (HD DIP)
-  -CBRHDSH2-40: 2.0A, 40V Schottky (HD DIP)
-  -CBRHDSH2-100: 2.0A, 100V Schottky (HD DIP)

• Bi-Directional Transient Voltage Suppressors









-  -1SMB170CA: 600W, 170V (SMB)
-  -1SMC170CA: 1500W, 170V (SMC)

Power Factor Correction (PFC)



• Schottky Diodes and Rectifiers



-  -CMLSH05-4: 0.5A, 40V Low V_F Schottky Diode (SOT-563)
-  -CMLSH1-40: 1.0A, 40V Schottky Rectifier (SOT-563)
-  -CMSH2-60: 2.0A, 60V Schottky Rectifier (SMB)
-  -CMSH2-100: 2.0A, 100V Schottky Rectifier (SMB)
-  -CMSH3-60: 3.0A, 60V Schottky Rectifier (SMC)
-  -CMDFSHC3-100: 3.0A, 100V Schottky Rectifier (SMC DFN)
-  -CMDFSHC5-100: 5.0A, 100V Schottky Rectifier (SMC DFN)

• Ultra Fast Recovery Rectifiers





-  -CMR3S-04: 3.0A, 400V, 35ns (SMC)
-  -CMR3U-04: 3.0A, 400V, 50ns (SMB)

Control Circuitry and DC-DC continued on reverse side



Control Circuitry



• Schottky Diodes

-  -CMAD6263: 70mA, 70V (SOD-923)
-  -CMSSH-3: 100mA, 30V (SOT-323)
-  -CMLSH05-4: 0.5A, 40V Low V_F (SOT-563)



• Schottky Rectifier

-  -CMLSH1-40: 1.0A, 40V (SOT-563)



• Switching Diodes

-  -CMOD3003: 200mA, 180V (SOD-523)
-  -CMHD4448: 250mA, 100V (SOD-123)
-  -CMDD4448: 250mA, 100V (SOD-323)

• Small Signal Transistors

-  -CMPT3904: 200mA, 40V NPN (SOT-23)
-  -CMNT3904E: 200mA, 60V NPN (SOT-953)
-  -CMNT3906E: 200mA, 60V PNP (SOT-953)

• MOSFETs







-  -CEDM7001: 100mA, 20V N-Channel (SOT-883L)
-  -CEDM8001: 100mA, 20V P-Channel (SOT-883L)
-  -CEDM8004: 450mA, 30V P-Channel (SOT-883L)

• Zener Diodes



-  -CMOZ5V6 thru CMOZ12V: 250W, 5.6V-12V (SOD-523)

DC-DC





• Schottky Rectifiers

-  -CMLSH1-40: 1.0A, 40V (SOT-563)
-  -CMMSH1-40: 1.0A, 40V (SOD-123F)
-  -CMSH2-40M: 2.0A, 40V (SMA)
-  -CMSH3-40M: 3.0A, 40V (SMB)
-  -CMDFSHC3-100: 3.0A, 100V (SMC DFN)
-  -CMDFSHC5-100: 5.0A, 100V (SMC DFN)



• Small Signal Transistors Low $V_{CE(SAT)}$

-  -CMUT3410: 1.0A, 25V NPN (SOT-523)
-  -CMUT7410: 1.0A, 25V PNP (SOT-523)

• MOSFETs

-  -CEDM8004: 450mA, 30V P-Channel (SOT-883L)
-  -CMPDM7120G: 1.0A, 20V N-Channel (SOT-23)
-  -CMPDM202PH: 2.3A, 20V P-Channel (SOT-23F)
-  -CMPDM203NH: 3.2A, 20V N-Channel (SOT-23F)

• Current Limiting Diode (CLD)

-  -CMJH180: 18mA, 4.6V (SOD-123FL)
-  -CMJA5050: Adjustable 50mA - 80mA (DFN123F)

Samples



To order samples of these devices visit:
www.centalsemi.com